



AP-5IE64251AU

60cm Induction Cooktop

Features & Benefits

Easy Cleaning

Frameless, flush installation to reduce cleaning surface. Glass top means a regular kitchen surface cleaner should be enough.

Efficiency

Pot detection switching for less panel operation. Cooking zone booster for quick heating.

Cooking Assist

Timer and countdown function available.

Stylish Design

Sleek glass look in black colour that suits any modern style.

Space Saving

Flush installation integrates the surface for a wider workstation space. Slim and flat design requires less space for installation.

Safety Feature

Child lock and residual heat indicators to avoid accidents. A safety switch off is available in case of emergency.

Multiple Cooking Zones

4 zones that can be simultaneously used.

Display and Controls

Touch control panel and 7-segment digital LED display located in front. Electronic control in 10 power levels.

Energy Source

Electricity

Specification

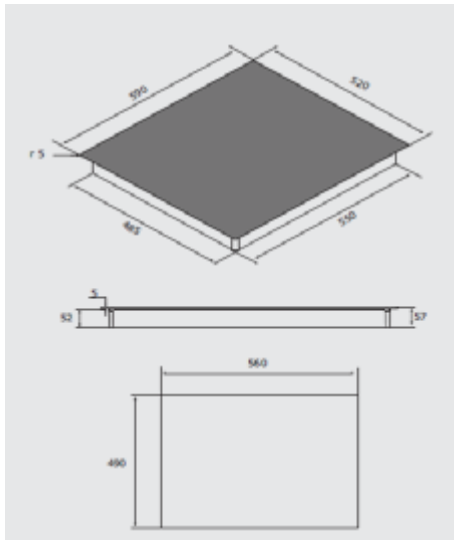

Dimensions

Appliance:
H57 x W590 x D520mm
Installation:
H61 x W560 x D490mm

Material

Surface: Glass ceramic

Weight

Net: 10.54kg

Type

Built-in, frameless
combi-induction

Finish

Black

Cooking Zone Power (+Booster)

2 zones Ø 16cm
- 1.2 kW (1.4 kW)
2 zones Ø 16cm
- 2.3 kW (3 kW)

Control

Touch control panel
located in front
Pot detection

Display

LED display with 7
segments
Residual heat indicator

Connection

- Voltage: 220-240 V
- Total connected load: 7.4 kW
- Frequency: 50/60 Hz
- Device color: Black
- Energy Source: Electric
- Approval certificates: CE, RCM
- Packaged unit dimensions: 715 x 654 x 125 mm
- Niche dimensions: 48 x 560-560 x 490-500 mm
- Device width: 590mm
- Dimensions of the device: 52 x 590 x 520mm
- Length of connection cable: N/A
- Plug type: without plug

Accessories

